

# dáváme plánům život

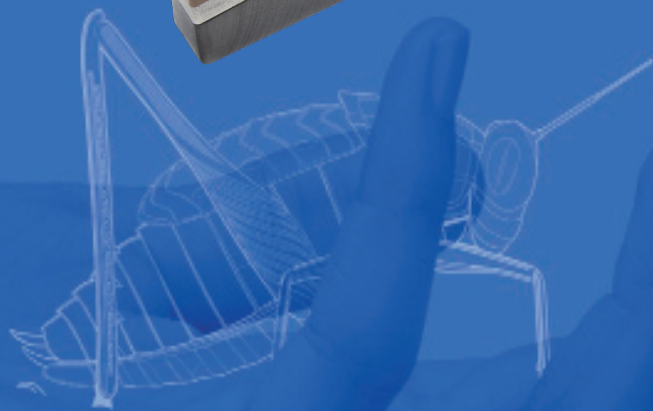

Zaujati strojírenstvím,

pohánění myšlenkami.

# Legenda

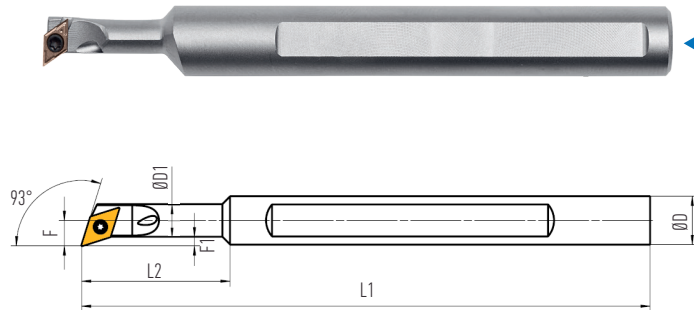
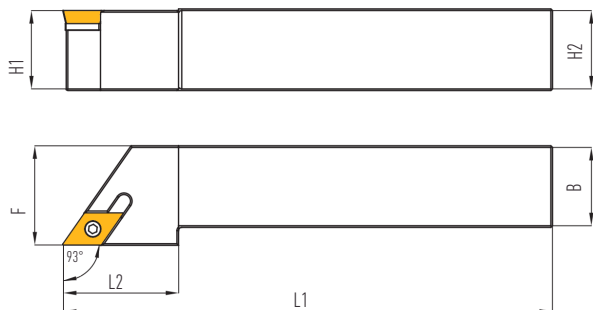

H1...výška hlavy  
 H2...výška stopky  
 F...šířka hlavy  
 B...šířka stopky  
 L1...celková délka  
 L2...délka hlavy

D...průměr držáku  
 D1...průměr odlehčení  
 L1...celková délka  
 L2...délka odlehčení  
 F...vzdálenost břitu od osy nástroje  
 F1...max.funkční hloubka

## Výběr nástrojového systému

VNĚJŠÍ SOUSTRUŽENÍ

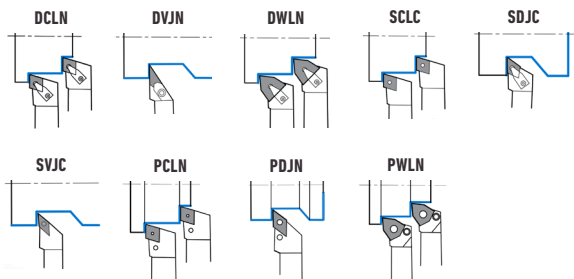

VNITŘNÍ SOUSTRUŽENÍ

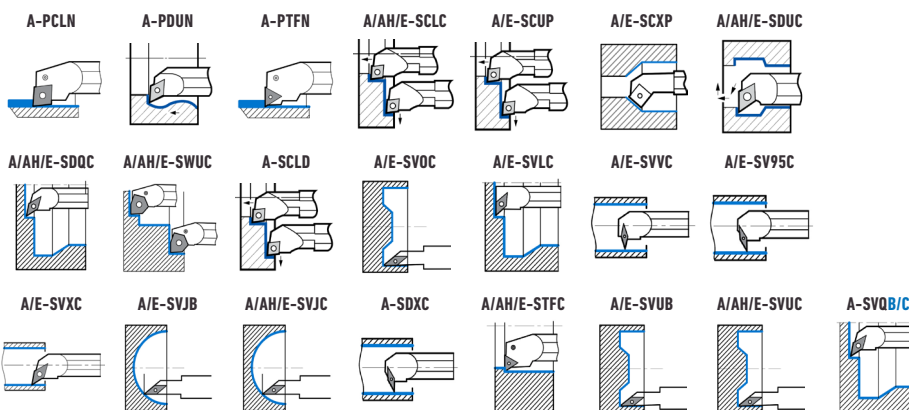

# PŘEHLED SOUSTRUŽENÍ

Materiál stopky ■ Ocel ■ HSS ■ Karbid



VNĚJŠÍ SOUSTRUŽENÍ			Strana
Držák	Operace	VBD	
DCLNR/L 20x20   25x25   32x32		 CNMG 1204.. (negativní)	4
DVJNR/L 16x16   20x20   25x25   32x32		 VNMG1604.. (negativní)	4
DWLNR/L 16x16   20x20   25x25   32x32		 WNMG 0602..J0804 (negativní)	4
SCLCR/L 8x8   až   32x32		 CCMT/CCGT 0602..J09T3..J1204.. (pozitivní)	5
SDJCR/L 16x16   20x20   25x25   32x32		 DCMT/DCGT 11T3.. (pozitivní)	5
SVJCR/L 16x16   20x20   25x25   32x32		 VCMT/VCGT 1604.. (pozitivní)	6
SCLCR/L 16x16   20x20   25x25		 CCMT/CCGT 09T3..J1204.. (pozitivní)	6
SDJCR/L 16x16   20x20   25x25		 DCMT/DCGT 11T3.. (pozitivní)	6
SVJCR/L 16x16   20x20   25x25		 VCMT/VCGT 1103..J1604.. (pozitivní)	7
PCLNR/L 16x16   20x20   25x25		 CN. 1204.. (negativní)	7
PDJNR/L 16x16   20x20   25x25		 DN. 1104/1506.. (negativní)	8
PWLNR/L 20x20   25x25		 WN. 0804.. (negativní)	8

VNITŘNÍ SOUSTRUŽENÍ			Strana
Držák	Operace	VBD	
A-PCLNR/L Dmin 32-49 mm		 CN. 1204.. (negativní)	10
A-PDUNR/L Dmin 40 mm		 DN. 1506.. (negativní)	10
A-PTFNR/L Dmin 32 mm		 TN. 1103../1604.. (negativní)	10
A-SCLCR/L Dmin 8,5-18 mm		 CCMT/CCGT 0602.. (pozitivní)	11
AH-SCLCR/L Dmin 8,5-18 mm		 CCMT/CCGT 0602.. (pozitivní)	11
A-SCLDR/L Dmin 4,8-6,8 mm		 CCGT 0401.. (pozitivní)	11
E-SCLDR/L Dmin 4,8-6,8 mm		 CCGT 0401.. (pozitivní)	11
A-SCUPR/L Dmin 8-16 mm		 CPMT/CPGT 05T1.. (pozitivní)	12
E-SCUPR/L Dmin 8-16 mm		 CPMT/CPGT 05T1.. (pozitivní)	12
A-SCXPR/L Dmin 8,5-16 mm		 CPMT/CPGT 05T1.. (pozitivní)	12
E-SCXPR/L Dmin 8,5-16 mm		 CPMT/CPGT 05T1.. (pozitivní)	12
A-SDUCR/L Dmin 5,6-18 mm		 DCMT/DCGT 0702..J0CGT 04T0.. (pozitivní)	13

VNITŘNÍ SOUSTRUŽENÍ			Strana
Držák	Operace	VBD	
E-SDUCR/L Dmin 5,6-18 mm		 DCGT 04T0.. (pozitivní)	13
A-SDQCR/L Dmin 5,2-19,5 mm		 DCMT/DCGT 0702..J0CGT 04T0.. (pozitivní)	13
E-SDQCR/L Dmin 5,2 mm		 DCGT 04T0.. (pozitivní)	13
A-SWUCR/L Dmin 5,8-7,8 mm		 WCMT/WCGT 0201.. (pozitivní)	14
AH-SWUCR/L Dmin 5,8-7,8 mm		 WCMT/WCGT 0201.. (pozitivní)	14
E-SWUCR/L Dmin 5,8-7,8 mm		 WCMT/WCGT 0201.. (pozitivní)	14
A-SWUCR/L Dmin 5,8-7,8 mm		 WCMT/WCGT 0201.. (pozitivní)	14
A-SCLDR/L Dmin 4,8-6,8 mm		 CDGT.0401.. (pozitivní)	15
A-SVOCR/L Dmin 8-24 mm		 VCMT/VCGT 0702../1103../J0CGT 0501.. (pozitivní)	15
E-SVOCR/L Dmin 8-11 mm		 VCMT/VCGT 0702..J0CGT 0501.. (pozitivní)	15
A-SVLCR/L Dmin 9,2-19,5 mm		 VCMT/VCGT 0702..J0CGT 0501.. (pozitivní)	16
E-SVLCR/L Dmin 9,2-19,5 mm		 VCMT/VCGT 0702..J0CGT 0501.. (pozitivní)	16

VNITŘNÍ SOUSTRUŽENÍ			Strana
Držák	Operace	VBD	
A-SVVCRL Dmin 10,2-34 mm		 VCMT/VCGT 0702../1103../1604../J0CGT 0501.. (pozitivní)	16
E-SVVCRL Dmin 10,2-19,5 mm		 VCMT/VCGT 0702..J0CGT 0501.. (pozitivní)	17
A-SV95CR/L Dmin 9,2-19,5 mm		 VCMT/VCGT 0702..J0CGT 0501.. (pozitivní)	17
E-SV95CR/L Dmin 9,2-19,5 mm		 VCMT/VCGT 0702..J0CGT 0501.. (pozitivní)	17
A-SVXCR/L Dmin 9,2-19,5 mm		 VCMT/VCGT 0702..J0CGT 0501.. (pozitivní)	18
E-SVXCR/L Dmin 9,2-19,5 mm		 VCMT/VCGT 0702..J0CGT 0501.. (pozitivní)	18
A-SVJBR/L Dmin 22-28 mm		 VBMT/VBGT 1103../1604.. (pozitivní)	18
E-SVJBR/L Dmin 22-28 mm		 VBMT/VBGT 1103../1604.. (pozitivní)	18
A-SVJCR/L Dmin 8-28 mm		 VCMT/VCGT 0702../1103../1604../J0CGT 0501.. (pozitivní)	19
AH-SVJCR/L Dmin 22-28 mm		 VCMT/VCGT 1103../1604.. (pozitivní)	19
E-SVJCR/L Dmin 8-28 mm		 VCMT/VCGT 0702../1103../1604../J0CGT 0501.. (pozitivní)	19
A-SCLCR/L Dmin 10-49 mm		 CCMT/CCGT 0602..J09T3../1204.. (pozitivní)	20

VNITŘNÍ SOUSTRUŽENÍ			Strana
Držák	Operace	VBD	
AH-SCLCR/L Dmin 5-28 mm		 CCMT/CCGT 0602..J09T3../1204../J0CGT 0301.. (pozitivní)	20
E-SCLCR/L Dmin 5-39 mm		 CCMT/CCGT 0602..J09T3../1204../J0CGT 0301.. (pozitivní)	20
A-SDUCR/L Dmin 5-49 mm		 DCMT/DCGT 0702../11T3.. (pozitivní)	21
AH-SDUCR/L Dmin 12-32 mm		 DCMT/DCGT 0702../11T3.. (pozitivní)	21
E-SDUCR/L Dmin 12,5-32 mm		 DCMT/DCGT 0702../11T3.. (pozitivní)	21
A-SDQCR/L Dmin 14-49 mm		 DCMT/DCGT 0702../11T3.. (pozitivní)	22
AH-SDQCR/L Dmin 12-32 mm		 DCMT/DCGT 0702../11T3.. (pozitivní)	22
E-SDQCR/L Dmin 9,2-31,5 mm		 DCMT/DCGT 0702../11T3.. (pozitivní)	22
A-SDXCR/L Dmin 9,2-31,5 mm		 DCMT/DCGT 0702../11T3../J0CGT 04T0.. (pozitivní)	23
A-STFCR/L Dmin 13-49 mm		 TCMT/TCGT 1102../16T3.. (pozitivní)	23
AH-STFCR/L Dmin 12-28 mm		 TCMT/TCGT 1102../16T3.. (pozitivní)	23
E-STFCR/L Dmin 12-27 mm		 TCMT/TCGT 1102../16T3.. (pozitivní)	24

VNITŘNÍ SOUSTRUŽENÍ			Strana
Držák	Operace	VBD	
A-SVUBR/L Dmin 21-49 mm		 VBMT/VBGT 1103../1604.. (pozitivní)	24
E-SVUBR/L Dmin 21-31,5 mm		 VBMT/VBGT 1103.. (pozitivní)	24
A-SVUCR/L Dmin 21-49 mm		 VCMT/VCGT 1103../1604.. (pozitivní)	25
AH-SVUCR/L Dmin 21-31,5 mm		 VCMT/VCGT 1103../1604.. (pozitivní)	25
E-SVUCR/L Dmin 21-31,5 mm		 VCMT/VCGT 1103.. (pozitivní)	25
A-SVQBR/L Dmin 21-32 mm		 VBMT/VBGT 1103../1604.. (pozitivní)	26
AH-SVQBR/L Dmin 21-49 mm		 VCMT/VCGT 1103../1604.. (pozitivní)	26
E-SVQBR/L Dmin 10-27 mm		 CCMT/CCGT 0602..J09T3../1204../J0CGT 0301.. (pozitivní)	26
A-SDUCR/L Dmin 13-31 mm		 DCMT/DCGT 0702../11T3.. (pozitivní)	27
A-SDQCR/L Dmin 13-31 mm		 DCMT/DCGT 0702../11T3.. (pozitivní)	27
A-STFCR/L Dmin 12-22 mm		 TCMT/TCGT 1102.. (pozitivní)	28
E-SVUBR/L Dmin 20-31 mm		 VBMT/VBGT 1103../1604.. (pozitivní)	28



# System značení držáku

## Vnější soustružení



### 1. System upnutí

Symbol	Typ upnutí	Příklad
C	Horní upnutí	
D	Dvojitě upnutí	
E	Upnutí kolíkem (VBD se opírá jednou plochou)	
M	Horní upnutí + přes otvor	
P	Upnutí pákou (VBD se opírá jednou plochou)	
S	Upnutí šroubem	

### 2. Tvar VBD

C	80°	D	55°	E	75°	F	50°	V	35°	R	○
S	90°	T	40°	W	80°	A	85°	B	82°	K	55°
H	120°	O	135°	P	108°	L	90°	M	86°		

### 3. Typ držáku

	Tvar	Ofset		Tvar	Ofset
A		○	L		●
B		○	N		○
D		○	R		●
E		○	S		●
F		●	T		●
G		●	U		●
J		●	W		●
K		●	Y		●

### 4. Úhel hřbetu

A	3°	
B	5°	
C	7°	
D	15°	
E	20°	
F	25°	
G	30°	
N	0°	
P	11°	

### 5. Směr posuvu

	S (mm)	
R		Přavostranný posuv
N		Neutrální posuv
L		Levostranný posuv

### 6. Výška stopky

	Výška (mm)		Šířka (mm)	
12	12	12	12	12
16	16	16	16	16
20	20	20	20	20
25	25	25	25	25
32	32	32	32	32
40	40	40	40	40
50	50	50	50	50
00	Kruhová stopka		Průměr kruhové stopky	

\* 2-ciferné číslo v milimetrech

### 7. Šířka stopky

	Délka (mm)
F	80
H	100
K	125
M	150
N	160
P	170
Q	180
S	250
T	300
U	350

\* Místo písmena může být jen pomlčka

### 9. Břit

	Délka (mm)			
VBD		VBD		
06	6,9	10	10	
08	8,2	12	12	
09	9,6	16	16	
11	11,0	20	20	
16	16,5	25	25	
22	22,0	32	32	
27	27,5			
33	33,0			



# Soustružnické nože vnější

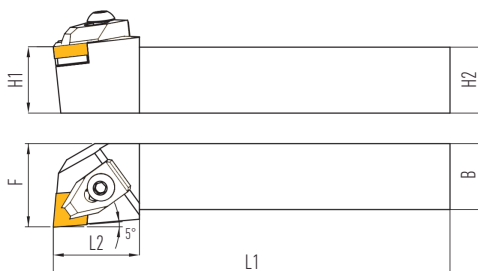

## Typ DCLNR/L

	Název	Rozměry (mm)						Destičky	Náhradní díly				
		H1	H2	B	L1	L2	F		Podložka	Šroubek podložky	Upínka	Šroubek upínky	Klíč
stopka ocelová	DCLNR/L 2020 K12	20	20	20	125	35	25	CNMG1204..	TMP-CN12	TMSP-M4x10 A2,5	TMU-120105	TMSU-M6x27	H3
	DCLNR/L 2525 M12	25	25	25	150	40	32						
	DCLNR/L 3232 P12	32	32	32	170	40	40						

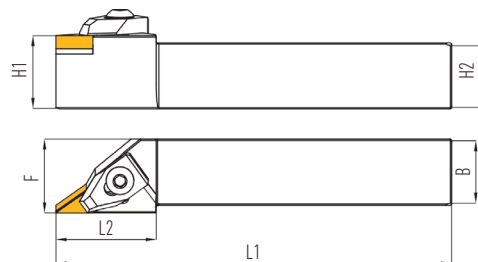

## Typ DVJNR/L

	Název	Rozměry (mm)						Destičky	Náhradní díly				
		H1	H2	B	L1	L2	F		Podložka	Šroubek podložky	Upínka	Šroubek upínky	Klíč
stopka ocelová	DVJNR/L 1616 K16	16	16	16	125	35	25	VNMG1604..	TMP-VN16	TMSP-M4x11 T15	TMU-160105	TMSU-M6x27	H3
	DVJNR/L 2020 K16	20	20	20	125	35	25						
	DVJNR/L 2525 M16	25	25	25	150	40	32						
	DVJNR/L 3232 P16	32	32	32	170	40	40						

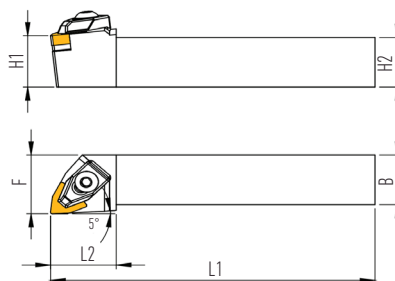

## Typ DWLNR/L

	Název	Rozměry (mm)						Destičky	Náhradní díly				
		H1	H2	B	L1	L2	F		Podložka	Šroubek podložky	Upínka	Šroubek upínky	Klíč
stopka ocelová	DWLNR/L 1616 K06	16	16	16	125	30	21	WNMG0602..	-	-	TMU-060105	TMSU-M5x15	H3
	DWLNR/L 2020 K06	20	20	20	125	35	25						
	DWLNR/L 2525 M06	25	25	25	150	40	32						
	DWLNR/L 2020 K08	20	20	20	125	35	25	WNMG0804..	TMP-WN08	TMSP-M4x10 A2,5	TMU-080105	TMSU-M6x27	
	DWLNR/L 2525 M08	25	25	25	150	40	32						
	DWLNR/L 3232 P08	32	32	32	170	40	40						



# Soustružnické nože vnější

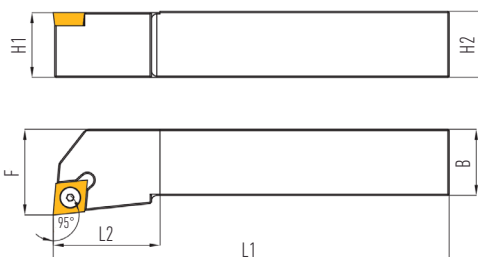

## Typ SCLCR/L

Název	Rozměry (mm)						Destičky	Náhradní díly				
	H1	H2	B	L1	L2	F		Podložka	Šroubek podložky	Šroubek VBD	Klíč	
stopka ocelová	SCLCR/L 0808 H06	8	8	8	100	20	10	CCMT/CCGT0602..	-	-	TMSV-M2,5x5	TX8
	SCLCR/L 1010 H06	10	10	10	100	20	12					
	SCLCR/L 1212 H06	12	12	12	100	20	15					
	SCLCR/L 1616 H06	16	16	16	100	25	20	CCMT/CCGT09T3..	-	-	TMSV-M3,5x8	TX15
	SCLCR/L 1212 H09	12	12	12	100	20	15					
	SCLCR/L 1616 H09	16	16	16	100	25	20					
	SCLCR/L 2020 K09	20	20	20	125	35	25	CCMT/CCGT1204..	TMP-CC12	TMSP-M6X0.75X4	TMSV-M4x16	TX15
	SCLCR/L 2525 M09	25	25	25	150	35	32					
	SCLCR/L 1616 H12	16	16	16	100	25	20					
	SCLCR/L 2020 K12	20	20	20	125	35	25	CCMT/CCGT1204..	TMP-CC12	TMSP-M6X0.75X4	TMSV-M4x16	TX15
	SCLCR/L 2525 M12	15	15	15	150	35	32					
	SCLCR/L 3232 P12	32	32	32	170	40	40					

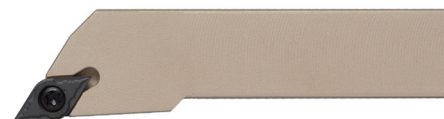
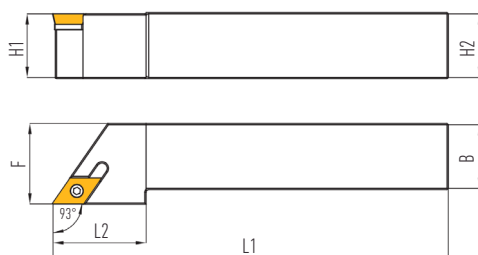

## Typ SDJCR/L

Název	Rozměry (mm)						Destičky	Náhradní díly				
	H1	H2	B	L1	L2	F		Podložka	Šroubek podložky	Šroubek VBD	Klíč	
stopka ocelová	SDJCR/L 1616 H11	16	16	16	100	25	25	DCMT/DCGT11T3..	TMP-DC11	TMSP-M5x05xM3,5	TMSV-M3,5x14	TX15
	SDJCR/L 2020 K11	20	20	20	125	35	35					
	SDJCR/L 2525 M11	25	25	25	150	40	40					
	SDJCR/L 3232 P11	32	32	32	170	40	40					



# Soustružnické nože vnější

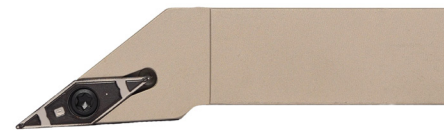
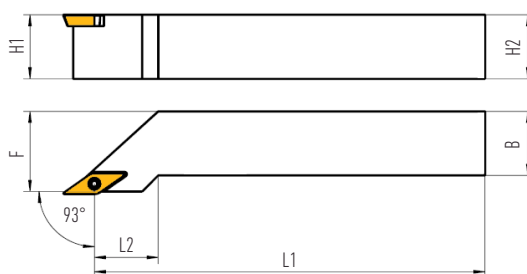

## Typ SVJCR/L

Název	Rozměry (mm)						Destičky	Podložka	Náhradní díly		
	H1	H2	B	L1	L2	F			Šroubek podložky	Šroubek VBD	Klíč
stopka ocelová SVJCR/L 1616 H16	16	16	16	100	25	25	VCMT/VCGT1604..	TMP-VC16	TMSP-M5x05xM3,5	TMSV-M3,5x14	TX15
SVJCR/L 2020 K16	20	20	20	125	35	35					
SVJCR/L 2525 M16	25	25	25	150	40	40					
SVJCR/L 3232 P16	32	32	32	170	40	40					

# Soustružnické nože vnější

s vnitřním chlazením

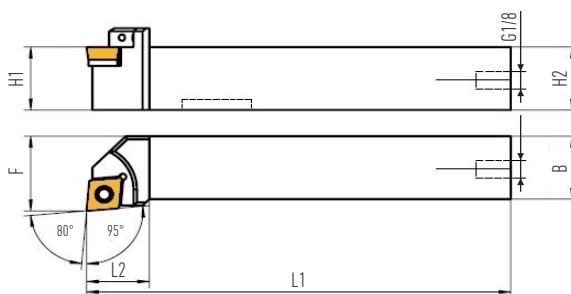

součástí dodávky



## Typ SCLCR/L



Název	Rozměry (mm)						Destičky	Podložka	Náhradní díly		
	H1	H2	B	L1	L2	F			Šroubek podložky	Šroubek VBD	Klíč
stopka ocelová SCLCR/L 1616H091KG1/8	16	16	16	100	17	20	CCMT/CCGT09T3..	US1111	GBS1111	SS1111	TX15
SCLCR/L 2020K091KG1/8	20	20	20	125	17	25					
SCLCR/L 2525M121KG1/8	25	25	25	150	20	32					

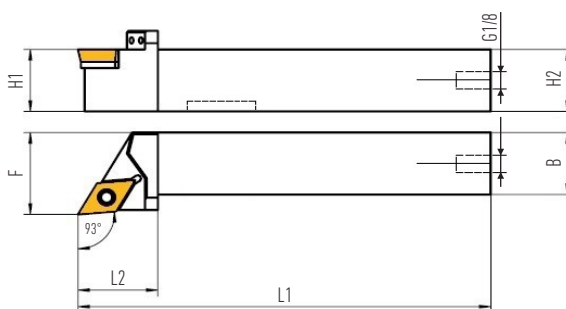

součástí dodávky

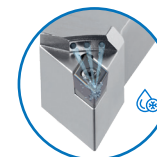

## Typ SDJCR/L



Název	Rozměry (mm)						Destičky	Podložka	Náhradní díly		
	H1	H2	B	L1	L2	F			Šroubek podložky	Šroubek VBD	Klíč
stopka ocelová SDJCR/L 1616H111KG1/8	16	16	16	100	20	20	DCMT/DCGT11T3..	US2311	GBS1111	SS1111	TX15
SDJCR/L 2020K111KG1/8	20	20	20	125	24	25					
SDJCR/L 2525M111KG1/8	25	25	25	150	27	32					





# Soustružnické nože vnější

s vnitřním chlazením

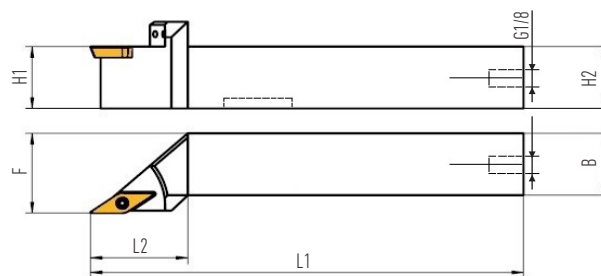

Typ SVJCR/L



Název	Rozměry (mm)						Destičky	Podložka	Náhradní díly		
	H1	H2	B	L1	L2	F			Šroubek podložky	Šroubek VBD	Klíč
stopka ocelová SVJCR/L1616H11IKG1/8	16	16	16	100	21,5	20	VCMT/VCGT1103..	-	-	SS1751	TX8
SVJCR/L2020K11IKG1/8	20	20	20	125	23	25					
SVJCR/L2020K16IKG1/8	20	20	20	125	29,5	25	VCMT/VCGT1604..	US6522	GBS1111	SS1111	TX15
SVJCR/L2525M16IKG1/8	25	25	25	150	32,5	32					

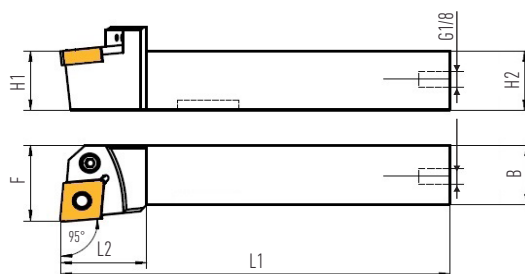

Typ PCLNR/L



Název	Rozměry (mm)						Destičky	Podložka	Náhradní díly			
	H1	H2	B	L1	L2	F			Páčka	Šroubek	Pružná podložka	Montážní čep
stopka ocelová PCLNR/L1616H12IKG1/8	16	16	16	100	26,1	20	CN..1204..	UP1111	HP1111	SP1111	RP1111	MP1111
PCLNR/L2020K12IKG1/8	20	20	20	125	27,4	25						
PCLNR/L2525M12IKG1/8	25	25	25	150	28	32						



# Soustružnické nože vnější

s vnitřním chlazením

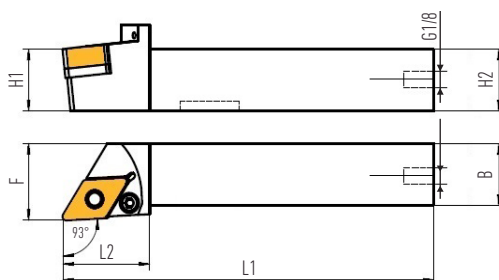

součástí dodávky

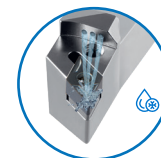

Typ PDJNR/L



Název	Rozměry (mm)						Destičky	Podložka	Náhradní díly			
	H1	H2	B	L1	L2	F			Páčka	Šroubek	Pružná podložka	Montážní čep
stopka ocelová PDJNR/L1616H11KG1/8	16	16	16	100	30	20	DN..1104..	UP2011	HP2011	SP3111	RP3112	MP3111
PDJNR/L2020K15KG1/8	20	20	20	125	30	25	DN..1506..	UP2421	HP2421	SP1111	RP1111	MP1111
PDJNR/L2525M15KG1/8	25	25	25	150	30	32						

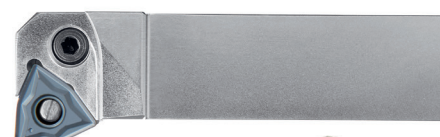
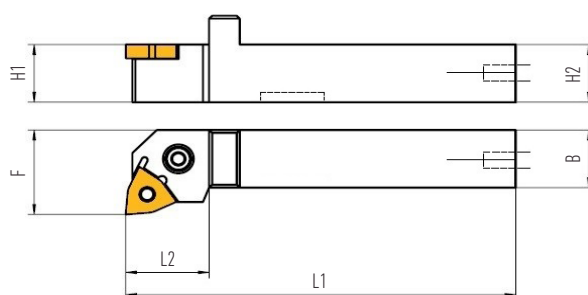

součástí dodávky

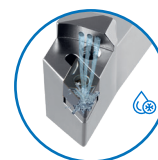

Typ PWLNR/L



Název	Rozměry (mm)						Destičky	Podložka	Náhradní díly			
	H1	H2	B	L1	L2	F			Páčka	Šroubek	Pružná podložka	Montážní čep
stopka ocelová PWLNR/L2020K08IKG1/8	20	20	20	125	25	25	WN..0804..	UP71011	HP1111	SP1111	RP1111	MP1111
PWLNR/L2525M08IKG1/8	25	25	25	150	25	32						



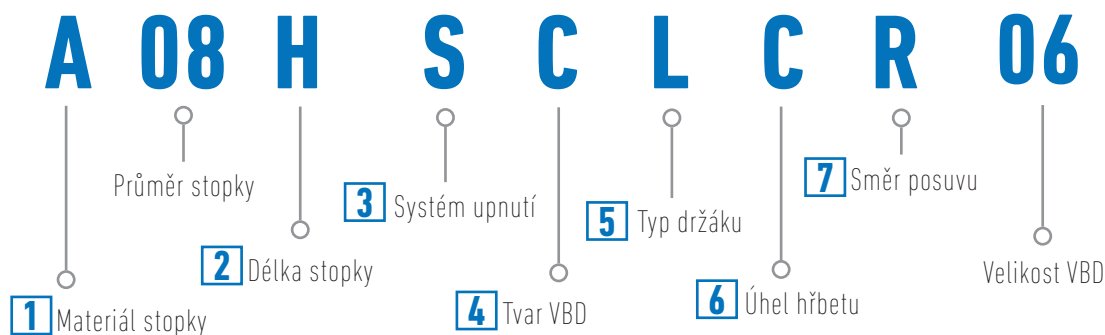

### 1. Materiál stopky

A	Ocel
B	Ocel s antivibračním mechanismem bez otvoru pro vnitřní chlazení
C	Karbid
D	Ocel s antivibračním mechanismem s otvorem pro vnitřní chlazení
E	Karbid s otvorem pro vnitřní chlazení

### 2. Délka stopky

E	70	N	160
F	80	P	170
G	90	Q	180
H	100	R	200
J	110	S	250
K	125	T	300
L	140	U	350
M	150	V	400

### 3. Systém upnutí

Symbol	Typ upnutí	Příklad
C	Horní upnutí	
D	Dvojité upnutí	
E	Upnutí kolíkem (VBD se opírá jednou plochou)	
M	Horní upnutí + přes otvor	
P	Upnutí pákou (VBD se opírá jednou plochou)	
S	Upnutí šroubem	

### 4. Tvar VBD

C	80°	D	55°	E	75°	F	50°	V	35°	R	○
S	90°	T	40°	W	80°	A	85°	B	82°	K	55°
H	120°	O	135°	P	108°	L	90°	M	186°		

### 5. Typ držáku

	Tvar	Tvar	Tvar
A		L	W
B		N	X
D		O	Y
E		Q	95
F		R	
G		S	
J		T	
K		U	

### 6. Úhel hřbetu

A	3°
B	5°
C	7°
D	15°
E	20°
F	25°
G	30°
N	0°
P	11°

### 7. Směr posuvu

	S (mm)	
R		Pravostranný posuv
N		Neutrální posuv
L		Levostranný posuv



# Soustružnické nože vnitřní



s vnitřním chlazením

## Typ A-PCLNR/L

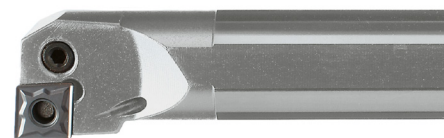
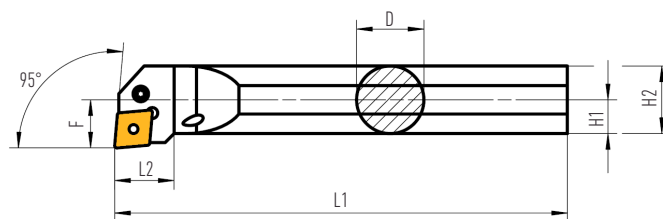

Název	Rozměry (mm)							Destičky	Podložka	Náhradní díly			
	D	Dmin	H1	H2	L1	L2	F			Páčka	Šroubek	Pružná podložka	Montážní čep
A25RPCLNR/L12	25	32	12,5	24	200	21	17				SP1114		
A32SPCLNR/L12	32	40	16	31	250	24,1	22	CN..1204..	UP1111	HP1111	SP1111	RP1111	MP1111
A40TPCLNR/L12	40	49	20	38,5	300	24,1	27						

## Typ A-PDUNR/L

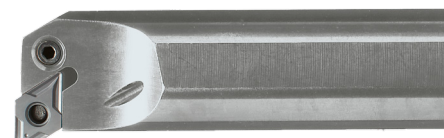
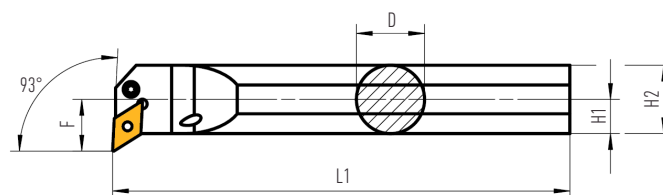

Název	Rozměry (mm)							Destičky	Podložka	Náhradní díly			
	D	Dmin	H1	H2	L1	L2	F			Páčka	Šroubek	Pružná podložka	Montážní čep
A32SPDUNR/L15	32	40	16	31	250	22	22	DN..1506..	UP2421	HP4751	SP1111	RP1111	MP1111

## Typ A-PTFNR/L

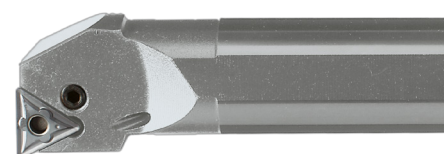
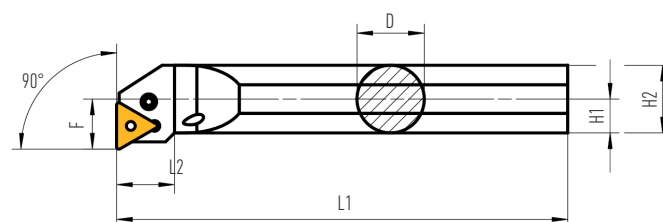

Název	Rozměry (mm)							Destičky	Podložka	Náhradní díly			
	D	Dmin	H1	H2	L1	L2	F			Páčka	Šroubek	Pružná podložka	Montážní čep
A25RPTFNR/L16	25	32	12,5	24	200	17,5	17	TN..1604..	UP6211	HP4751	SP3111	RP3112	MP3111



# Soustružnické nože vnitřní



odlehčené s vnitřním chlazením

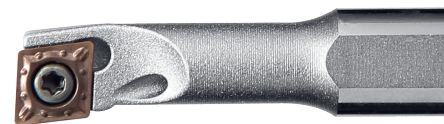
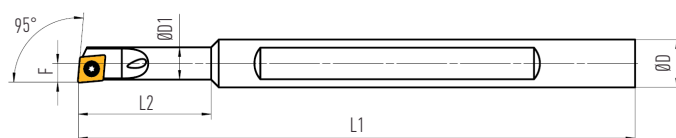

## Typ A-SCLCR/L



Název	Rozměry (mm)						Destičky	Náhradní díly	
	D	D1	Dmin	L1	L2	F		Šroubek VBD	Klíč
stopka ocelová A0608HSCLCR/L06	8	6	8,5	100	21,5	4,2	CCMT/CCGT0602..	VT25 B	TX8
A0810JSCLCR/L06	10	8	12	110	27	6			
A1012KSCLCR/L06	12	10	14	125	32,5	7			
A1216MSCLCR/L06	16	12	18	150	42	9			

## Typ AH-SCLCR/L



Název	Rozměry (mm)						Destičky	Náhradní díly	
	D	D1	Dmin	L1	L2	F		Šroubek VBD	Klíč
stopka HSS AH0608HSCLCR/L06	8	6	8,5	100	25	4	CCMT/CCGT0602..	VT25 B	TX8
AH0810JSCLCR/L06	10	8	12	110	32	6			
AH1012KSCLCR/L06	12	10	14	125	38	7			
AH1216MSCLCR/L06	16	12	18	150	50	9			

## Typ A-SCLDR/L



Název	Rozměry (mm)						Destičky	Náhradní díly	
	D	D1	Dmin	L1	L2	F		Šroubek VBD	Klíč
stopka ocelová A0408HSCLDR/L04	8	4	4,8	100	16	2,4	CDGT0401..	VT18B	TX6
A0508HSCLDR/L04	8	5	5,8	100	20	2,9			
A0608HSCLDR/L04	8	6	6,8	100	24	3,4			

## Typ E-SCLDR/L



Název	Rozměry (mm)						Destičky	Náhradní díly	
	D	D1	Dmin	L1	L2	F		Šroubek VBD	Klíč
stopka karbidová E0408HSCLDR/L04	8	4	4,8	100	24	2,4	CDGT0401..	VT18B	TX6
E0508HSCLDR/L04	8	5	5,8	100	30	2,9			
E0608HSCLDR/L04	8	6	6,8	100	36	3,4			



# Soustružnické nože vnitřní



odlehčené s vnitřním chlazením

## Typ A-SCUPR/L

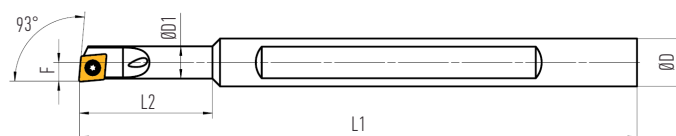

	Název	Rozměry (mm)					Destičky	Náhradní díly		
		D	D1	Dmin	L1	L2		F	Šroubek VBD	Klíč
stopka ocelová	A0608HSCUPR/L05	8	6	8	100	20	4,5	CPMT/CPGT05T1..	VT22 B	TX6
	A0810JSCUPR/L05	10	8	11	110	26	6			
	A1012KSCUPR/L05	12	10	13	125	32	7			
	A1216MSCUPR/L05	16	12	16	150	40	9			

## Typ E-SCUPR/L



	Název	Rozměry (mm)					Destičky	Náhradní díly		
		D	D1	Dmin	L1	L2		F	Šroubek VBD	Klíč
stopka karbidová	E0608HSCUPR/L05	8	6	8	100	28	4,5	CPMT/CPGT05T1..	VT22 B	TX6
	E0810JSCUPR/L05	10	8	11	110	36	6			
	E1012KSCUPR/L05	12	10	13	125	44	7			
	E1216MSCUPR/L05	16	12	16	150	55	9			

## Typ A-SCXPR/L

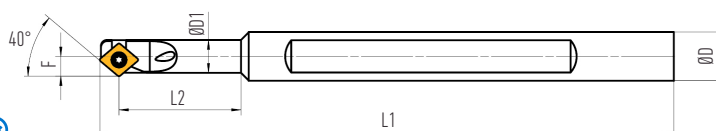

	Název	Rozměry (mm)					Destičky	Náhradní díly		
		D	D1	Dmin	L1	L2		F	Šroubek VBD	Klíč
stopka ocelová	A0608HSCXPR/L05	8	6	8,5	100	20	4,5	CPMT/CPGT05T1..	VT22 B	TX6
	A0810JSCXPR/L05	10	8	11	110	26	6			
	A1012KSCXPR/L05	12	10	13	125	32	7			
	A1216MSCXPR/L05	16	12	16	150	40	9			

## Typ E-SCXPR/L



	Název	Rozměry (mm)					Destičky	Náhradní díly		
		D	D1	Dmin	L1	L2		F	Šroubek VBD	Klíč
stopka karbidová	E0608HSCXPR/L05	8	6	8,5	100	28	4,5	CPMT/CPGT05T1..	VT22 B	TX6
	E0810JSCXPR/L05	10	8	11	110	36	6			
	E1012KSCXPR/L05	12	10	13	125	44	7			
	E1216MSCXPR/L05	16	12	16	150	55	9			



# Soustružnické nože vnitřní



odlehčené s vnitřním chlazením

## Typ A-SDUCR/L

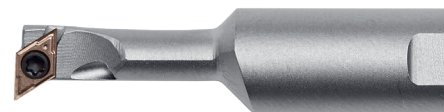
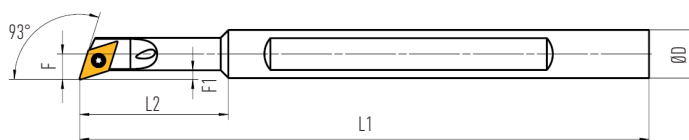

Název	Rozměry (mm)						Destičky	Náhradní díly		
	D	Dmin	L1	L2	F	F1		Šroubek VBD	Klíč	
stopka ocelová	A0408FSDUCR/L04	8	5,6	80	15	3	1,5	DCGT04T0..	VT1604	TX5
	A0810HSDUCR/L07	10	12,5	100	22,5	6,5	4,4	DCMT/DCGT0702..	VT25 B	TX8
	A1012KSDUCR/L07	12	15,5	125	27,5	9	5,9			
	A1216MSDUCR/L07	16	18	150	40,5	11	4,9			

## Typ E-SDUCR/L



Název	Rozměry (mm)						Destičky	Náhradní díly		
	D	Dmin	L1	L2	F	F1		Šroubek VBD	Klíč	
stopka karbidová	E0408FSDUCR/L04	8	5,6	80	26	3	1,5	DCGT04T0..	VT1604	TX5

## Typ A-SDQCR/L

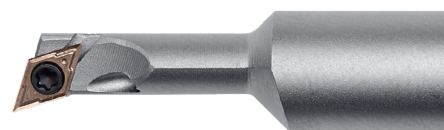
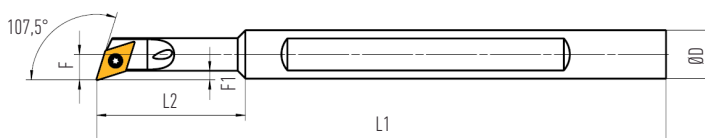

Název	Rozměry (mm)						Destičky	Náhradní díly		
	D	Dmin	L1	L2	F	F1		Šroubek VBD	Klíč	
stopka ocelová	A0408FSDQCR/L04	8	5,2	80	15	2,6	1,1	DCGT04T0..	VT1604	TX5
	A0810HSDQCR/L07	10	12,5	100	22,4	6,4	3	DCMT/DCGT0702..	VT25 B	TX8
	A1012KSDQCR/L07	12	15,5	125	27,5	9	4			
	A1216MSDQCR/L07	16	19,5	150	39,5	11	5			

## Typ E-SDQCR/L



Název	Rozměry (mm)						Destičky	Náhradní díly		
	D	Dmin	L1	L2	F	F1		Šroubek VBD	Klíč	
stopka karbidová	E0408FSDQCR/L04	8	5,2	80	26	2,6	1,1	DCGT04T0..	VT1604	TX5



# Soustružnické nože vnitřní



odlehčené s vnitřním chlazením

## Typ A-SWUCR/L

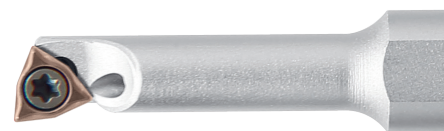
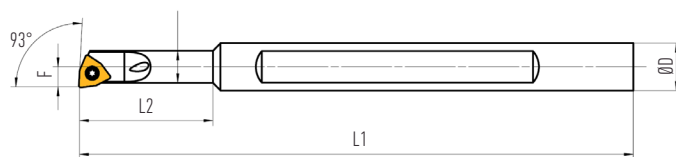

Název	Rozměry (mm)						Destičky	Náhradní díly		
	D	Dmin	D1	L1	L2	F		Šroubek VBD	Klíč	
stopka ocelová	A0508HSWUCR/L02	8	5,8	5	100	18	2,9	WCMT/WCGT0201..	VT20 B	TX6
	A0608HSWUCR/L02	8	7,8	6	100	24	3,9			

## Typ AH-SWUCR/L

Název	Rozměry (mm)						Destičky	Náhradní díly		
	D	Dmin	D1	L1	L2	F		Šroubek VBD	Klíč	
stopka HSS	AH0508HSWUCR/L02	8	5,8	5	100	18	2,9	WCMT/WCGT0201..	VT20 B	TX6
	AH0608HSWUCR/L02	8	7,8	6	100	24	3,9			

## Typ E-SWUCR/L

Název	Rozměry (mm)						Destičky	Náhradní díly		
	D	Dmin	D1	L1	L2	F		Šroubek VBD	Klíč	
stopka karbidová	E0508HSWUCR/L02	8	5,8	5	100	24	2,9	WCMT/WCGT0201..	VT20 B	TX6
	E0608HSWUCR/L02	8	7,8	6	100	32	3,9			

s vnitřním chlazením

## Typ E-SWUCR/L

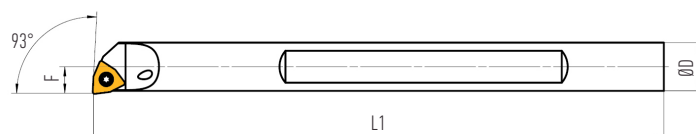

Název	Rozměry (mm)				Destičky	Náhradní díly		
	D	Dmin	L1	F		Šroubek VBD	Klíč	
stopka karbidová	E05FSWUCR/L02	5	5,8	85	2,9	WCMT/WCGT0201..	VT20 B	TX6
	E06GSWUCR/L02	6	7,8	95	3,9			





# Soustružnické nože vnitřní



s vnitřním chlazením

## Typ A-SCLDR/L



Název	Rozměry (mm)				Destičky	Náhradní díly	
	D	Dmin	L1	F		Šroubek VBD	Klíč
stopka ocelová A04ESCLDR/L04	4	4,8	70	2,4	CDGT0401..	VT18 B	TX6
A05ESCLDR/L04	5	5,8	70	2,9			
A06FSCLDR/L04	6	6,8	80	3,4			

## Typ A-SVOCR/L

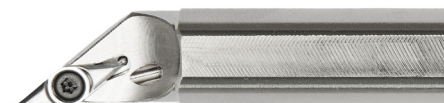
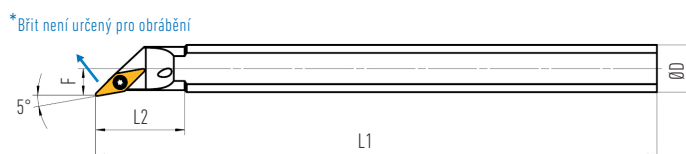

Název	Rozměry (mm)					Destičky	Náhradní díly	
	D	Dmin	L1	L2	F		Šroubek VBD	Klíč
stopka ocelová A08FSVOCR/L05	8	8	80	15	3	VCGT0501..	VT1604	TX5
A10HSVOCR/L07	10	13	100	22	5,5	VCMT/VCGT0702..	VT20	TX6
A12LSVOCR/L07	12	13	140	28	6,5			
A16MSVOCR/L11	16	22	150	36	9	VCMT/VCGT1103..	VT25 B	TX8
A20QSVOCR/L11	20	24	180	40	11			

## Typ E-SVOCR/L



Název	Rozměry (mm)					Destičky	Náhradní díly	
	D	Dmin	L1	L2	F		Šroubek VBD	Klíč
stopka karbidová E08FSVOCR/L05	8	8	80	26	3	VCGT0501..	VT1604	TX5
E10HSVOCR/L07	10	11	100	32	5,5	VCMT/VCGT0702..	VT20	TX6

## Redukce

Objednací číslo	Rozměry (mm)				
	Ød	ØD	L	L1	H
SC04-16	4				
SC05-16	5	16	80	6	15
SC06-16	6				

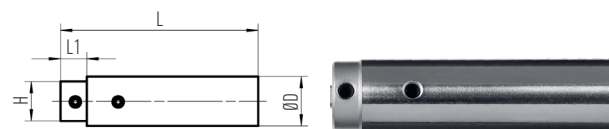

# Soustružnické nože vnitřní



odlehčené s vnitřním chlazením

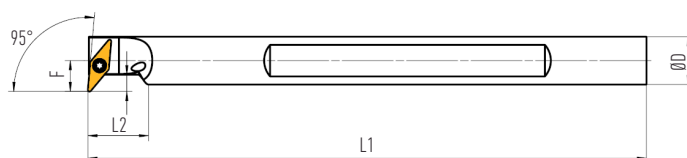

## Typ A-SVLCR/L



Název	Rozměry (mm)						Destičky	Náhradní díly	
	D	Dmin	L1	L2	F	F1		Šroubek VBD	Klíč
<b>stopka ocelová</b> A08FSVLCR/L05	8	9,2	80	15	5	3	VCGT0501..	VT1604	TX5
A10HSVLCR/L07	10	12,5	100	22	7	5	VCMT/VCGT0702..	VT20	TX6
A12KSVLCR/L07	12	15,5	125	28	9	6			
A16MSVLCR/L07	16	19,5	150	36	11	5			

## Typ E-SVLCR/L



Název	Rozměry (mm)						Destičky	Náhradní díly	
	D	Dmin	L1	L2	F	F1		Šroubek VBD	Klíč
<b>stopka karbidová</b> E08FSVLCR/L05	8	9,2	80	26	5	3	VCGT0501..	VT1604	TX5
E10HSVLCR/L07	10	12,5	100	32	7	5	VCMT/VCGT0702..	VT20	TX6
E12KSVLCR/L07	12	15,5	125	40	9	6			
E16MSVLCR/L07	16	19,5	150	55	11	5			

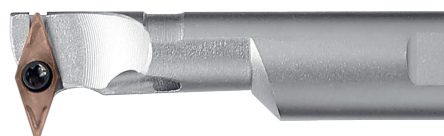
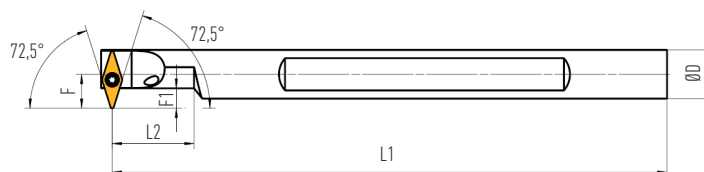

## Typ A-SVVCRL



Název	Rozměry (mm)						Destičky	Náhradní díly	
	D	Dmin	L1	L2	F	F1		Šroubek VBD	Klíč
<b>stopka ocelová</b> A08FSVVCRL05	8	10,2	80	15	5,5	3,5	VCGT0501..	VT1604	TX5
A10HSVVCRL07	10	13,5	100	22	8	6	VCMT/VCGT0702..	VT20	TX6
A12KSVVCRL07	12	15,5	125	28	9	6			
A16MSVVCRL07	16	19,5	150	36	11	6			
A16MSVVCRL11	16	23	150	40	13,9	9,5	VCMT/VCGT1103..	VT25 B	TX8
A20QSVVCRL11	20	25	180	50	13,9	9,5	VCMT/VCGT1604..	VT40 B	TX15
A25RSVVCRL16	25	34	200	62,5	19,9	13			



# Soustružnické nože vnitřní



odlehčené s vnitřním chlazením

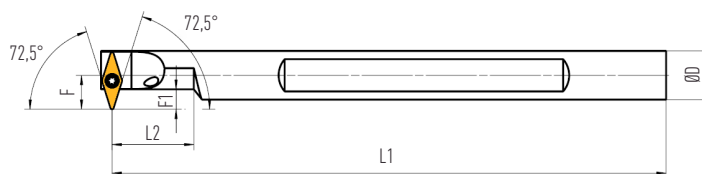

## Typ E-SVVCr/L



	Název	Rozměry (mm)					Destičky	Náhradní díly		
		D	Dmin	L1	L2	F		F1	Šroubek VBD	Klíč
stopka karbidová	E08FSVVCr/L05	8	10,2	80	26	5,5	3,5	VCGT0501..	VT1604	TX5
	E10HSVVCr/L07	10	13,5	100	32	8	6	VCMT/VCGT0702..	VT20	TX6
	E12KSVVCr/L07	12	15,5	125	40	9	6			
	E16MSVVCr/L07	16	19,5	150	55	11	6			

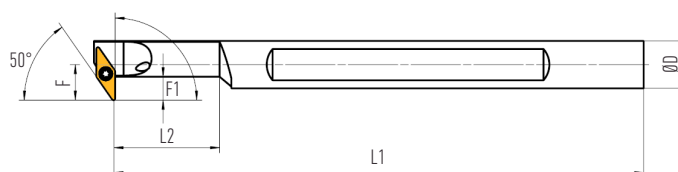

## Typ A-SV95Cr/L



	Název	Rozměry (mm)					Destičky	Náhradní díly		
		D	Dmin	L1	L2	F		F1	Šroubek VBD	Klíč
stopka ocelová	A08FSV95Cr/L05	8	9,2	80	15	5	3	VCGT 0501..	VT1604	TX5
	A10HSV95Cr/L07	10	12,5	100	22	7	5	VCMT/VCGT 0702..	VT20	TX6
	A12KSV95Cr/L07	12	15,5	125	28	9	6			
	A16MSV95Cr/L07	16	19,5	150	36	11	5			

## Typ E-SV95Cr/L



	Název	Rozměry (mm)					Destičky	Náhradní díly		
		D	Dmin	L1	L2	F		F1	Šroubek VBD	Klíč
stopka karbidová	E08FSV95Cr/L05	8	9,2	80	26	5	3	VCGT 0501..	VT1604	TX5
	E10HSV95Cr/L07	10	12,5	100	32	7	5	VCMT/VCGT 0702..	VT20	TX6
	E12KSV95Cr/L07	12	15,5	125	40	9	6			
	E16MSV95Cr/L07	16	19,5	150	55	11	8			



# Soustružnické nože vnitřní



odlehčené s vnitřním chlazením

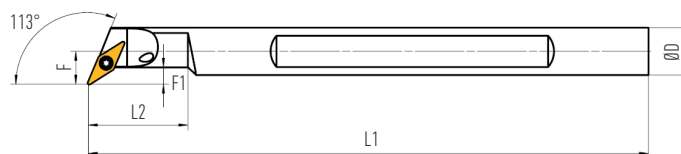

## Typ A-SVXCR/L



	Název	Rozměry (mm)					Destičky	Náhradní díly		
		D	Dmin	L1	L2	F		F1	Šroubek VBD	Klíč
stopka ocelová	A08FSVXCR/L05	8	9,2	80	15	5	3	VCGT0501..	VT1604	TX5
	A10HSVXCR/L07	10	12,5	100	22	7	3			
	A12KSVXCR/L07	12	15,5	125	28	9	3	VCMT/VCGT0702..	VT20	TX6
	A16MSVXCR/L07	16	19,5	150	36	11	3			

## Typ E-SVXCR/L



	Název	Rozměry (mm)					Destičky	Náhradní díly		
		D	Dmin	L1	L2	F		F1	Šroubek VBD	Klíč
stopka karbidová	E08FSVXCR/L05	8	9,2	80	26	5	3	VCGT0501..	VT1604	TX5
	E10HSVXCR/L07	10	12,5	100	32	7	3			
	E12KSVXCR/L07	12	15,5	125	40	9	3	VCMT/VCGT0702..	VT20	TX6
	E16MSVXCR/L07	16	19,5	150	55	11	3			

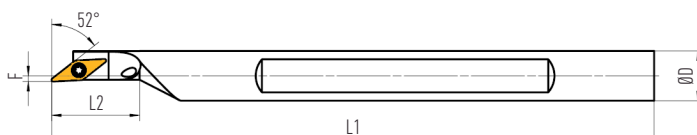

## Typ A-SVJBR/L



	Název	Rozměry (mm)				Destičky	Náhradní díly		
		D	Dmin	L1	L2		F	Šroubek VBD	Klíč
stopka ocelová	A16MSVJBR/L11	16	22	150	31,4	2	VBMT/VBGT1103..	VT25 B	TX8
	A20QSVJBR/L11	20	24	180	38	2			
	A25RSVJBR/L16	25	28	200	44	4,6	VBMT/VBGT1604..	VT40 B	TX15

## Typ E-SVJBR/L



	Název	Rozměry (mm)				Destičky	Náhradní díly		
		D	Dmin	L1	L2		F	Šroubek VBD	Klíč
stopka karbidová	E16RSVJBR/L11	16	22	200	31,4	2	VBMT/VBGT1103..	VT25 B	TX8
	E20SSVJBR/L11	20	24	250	38	2			
	E25SSVJBR/L16	25	28	250	44	4,6	VBMT/VBGT1604..	VT40 B	TX15



# Soustružnické nože vnitřní



odlehčené s vnitřním chlazením

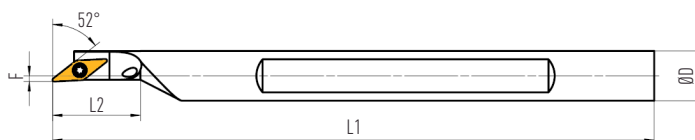

## Typ A-SVJCR/L



	Název	Rozměry (mm)				Destičky	Náhradní díly		
		D	Dmin	L1	L2		F	Šroubek VBD	Klíč
stopka ocelová	A08FSVJCR/L05	8	8	80	15	3	VCGT0501..	VT1604	TX5
	A10KSVJCR/L07	10	13	125	18	1,5	VCMT/VCGT0702..	VT20	TX6
	A12LSVJCR/L07	12	13	140	18	2			
	A16MSVJCR/L11	16	22	150	31,4	2	VCMT/VCGT1103..	VT25 B	TX8
	A20QSVJCR/L11	20	24	180	38	2			
	A25RSVJCR/L16	25	28	200	44	4,6			

## Typ AH-SVJCR/L



	Název	Rozměry (mm)				Destičky	Náhradní díly		
		D	Dmin	L1	L2		F	Šroubek VBD	Klíč
stopka HSS	AH16MSVJCR/L11	16	22	150	30	4,6	VCMT/VCGT1103..	VT25 B	TX8
	AH20QSVJCR/L11	20	25	180	38	4,6			
	AH25RSVJCR/L16	25	28	200	44	4,6	VCMT/VCGT1604..	VT40 B	TX15

## Typ E-SVJCR/L



	Název	Rozměry (mm)				Destičky	Náhradní díly		
		D	Dmin	L1	L2		F	Šroubek VBD	Klíč
stopka karbidová	E08FSVJCR/L05	8	8	80	26	3	VCGT0501..	VT1604	TX5
	E10KSVJCR/L07	10	13	125	18	1,5	VCMT/VCGT0702..	VT20	TX6
	E12MSVJCR/L07	12	13	150	18	2			
	E16RSVJCR/L11	16	22	200	31,4	2	VCMT/VCGT1103..	VT25 B	TX8
	E20SSVJCR/L11	20	24	250	38	2			
	E25SSVJCR/L16	25	28	250	44	4,6			



# Soustružnické nože vnitřní



s vnitřním chlazením

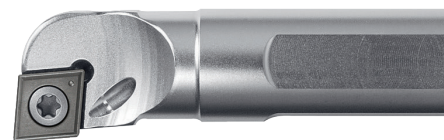
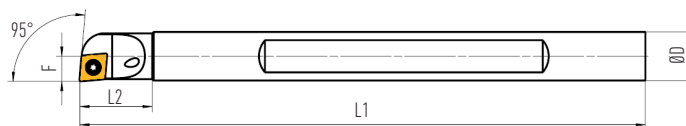

## Typ A-SCLCR/L



Název	Rozměry (mm)					Destičky	Náhradní díly				
	D	Dmin	L1	L2	F		Podložka	Šroubek podložky	Šroubek VBD	Klíč	
stopka ocelová	A08HSCLCR/L06	8	10	100	17,8	6	CCMT/CCGT0602..	-	-	VT25 B	TX8
	A10KSCLCR/L06	10	12	125	17,7	7		-	-	VT25 B	TX8
	A12LSCLCR/L06	12	16	140	24,2	9		-	-	VT25 B	TX8
	A16QSCLCR/L09	16	20	180	26,7	11	CCMT/CCGT09T3..	-	-	VT40 B	TX15
	A20RSCLCR/L09	20	25	200	36,7	13		-	-	VT40 B	TX15
	A25RSCLCR/L12	25	32	200	40	17	CCMT/CCGT1204..	-	-	VT50	TX20
	A32SSCLCR/L12	32	40	250	30	22		-	-	VT50	TX20
	A40T SCLCR/L12	40	49	300	31,4	27		US1221	GBS1221	SS1221	TX15

## Typ AH-SCLCR/L



Název	Rozměry (mm)					Destičky	Náhradní díly				
	D	Dmin	L1	L2	F		Podložka	Šroubek podložky	Šroubek VBD	Klíč	
stopka HSS	AH0410HSCLCR/L03	10	5	100	24	2,5	CCGT0301..	-	-	VT16	TX6
	AH0610HSCLCR/L03	10	7	100	32	3,5		-	-	VT16	TX6
	AH08KSCLCR/L06	8	10	125	20	5		-	-	VT16	TX6
	AH10KSCLCR/L06	10	12	125	20	6	CCMT/CCGT0602..	-	-	VT25 B	TX8
	AH12MSCLCR/L06	12	14	150	20	7		-	-	VT25 B	TX8
	AH16QSCLCR/L09	16	18	180	27	9	CCMT/CCGT09T3..	-	-	VT40 B	TX15
	AH20RSCLCR/L09	20	23	200	27	11		-	-	VT40 B	TX15
	AH25RSCLCR/L12	25	28	200	40	15,5		CCMT/CCGT1204..	-	-	VT50

## Typ E-SCLCR/L



Název	Rozměry (mm)					Destičky	Náhradní díly				
	D	Dmin	L1	L2	F		Podložka	Šroubek podložky	Šroubek VBD	Klíč	
stopka karbidová	E04GSCLCR/L03	4	5	90	10	2,5	CCGT0301..	-	-	VT16	TX6
	E05HSCLCR/L03	5	6	100	10	3		-	-	VT16	
	E06JSCLCR/L03	6	7	110	10	3,5		-	-	BFTX0104N	
	E08KSCLCR/L06	8	10	125	10	5	CCMT/CCGT0602..	-	-	VT25 B	TX8
	E10KSCLCR/L06	10	12	125	10	6		-	-	VT25 B	TX8
	E12MSCLCR/L06	12	14	150	10	8	CCMT/CCGT09T3..	-	-	VT40 B	TX15
	E16RSCLCR/L09	16	18	200	16	10		-	-	VT40 B	TX15
	E20SSCLCR/L09	20	23	250	16	12		-	-	VT40 B	TX15
	E25SSCLCR/L12	25	30	250	16	15	CCMT/CCGT1204..	-	-	VT50	TX20
	E32USCLCR/L12	32	39	350	26	22		US1221	GBS1221	SS1221	TX15



# Soustružnické nože vnitřní



s vnitřním chlazením

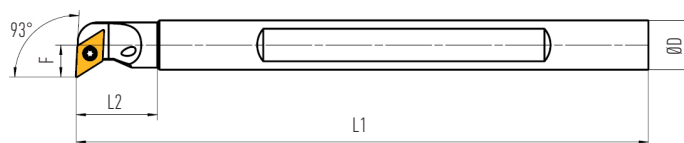

## Typ A-SDUCR/L

Název	Rozměry (mm)					Destičky	Náhradní díly				
	D	Dmin	L1	L2	F		Podložka	Šroubek podložky	Šroubek VBD	Klíč	
stopka ocelová	A10KSDUCR/L07	10	13,5	125	15,6	7	DCMT/DCGT0702..	-	-	VT25 B	TX8
	A12LSDUCR/L07	12	16	140	22,6	9		-	-	VT25 B	TX8
	A16QSDUCR/L07	16	20	180	27	11		-	-	VT25 B	TX8
	A20RSDUCR/L11	20	25	200	33,8	13	DCMT/DCGT11T3..	-	-	VT40 B	TX15
	A25RSDUCR/L11	25	32	200	35,8	17		-	-	VT40 B	TX15
	A32SSDUCR/L11	32	40	250	18,5	22		US2311	GBS1111	SS1111	TX20
A40TSDUCR/L11	40	49	300	18,5	27	-	-	VT40 B	TX15		

## Typ AH-SDUCR/L

Název	Rozměry (mm)					Destičky	Náhradní díly				
	D	Dmin	L1	L2	F		Podložka	Šroubek podložky	Šroubek VBD	Klíč	
stopka HSS	AH08KSDUCR/L07	8	12	125	20	7,5	DCMT/DCGT0702..	-	-	VT25 B	TX8
	AH10KSDUCR/L07	10	14	125	20	9		-	-	VT25 B	TX8
	AH12MSDUCR/L07	12	16	150	25	8		-	-	VT25 B	TX8
	AH16QSDUCR/L07	16	20	180	25	10	DCMT/DCGT11T3..	-	-	VT40 B	TX15
	AH20RSDUCR/L11	20	26	200	30	13		-	-	VT40 B	TX15
	AH25RSDUCR/L11	25	32	200	40	16		-	-	VT40 B	TX15

## Typ E-SDUCR/L

Název	Rozměry (mm)					Destičky	Náhradní díly				
	D	Dmin	L1	L2	F		Podložka	Šroubek podložky	Šroubek VBD	Klíč	
stopka karbidová	E08KSDUCR/L07	8	12,5	125	10	7,5	DCMT/DCGT0702..	-	-	VT25 B	TX8
	E10KSDUCR/L07	10	12,5	125	10	7		-	-	VT25 B	TX8
	E12MSDUCR/L07	12	15	150	12,5	9		-	-	VT25 B	TX8
	E16RSDUCR/L07	16	19	200	16,5	11	DCMT/DCGT11T3..	-	-	VT40 B	TX15
	E20SSDUCR/L11	20	23,5	250	20,5	12,5		-	-	VT40 B	TX15
	E25SSDUCR/L11	25	32	250	26	16		-	-	VT40 B	TX15



# Soustružnické nože vnitřní



s vnitřním chlazením

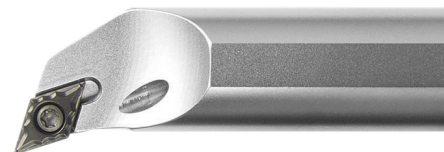
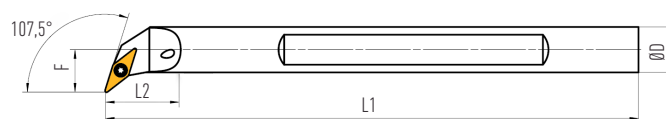

## Typ A-SDQCR/L

	Název	Rozměry (mm)					Destičky	Náhradní díly			
		D	Dmin	L1	L2	F		Podložka	Šroubek podložky	Šroubek VBD	Klíč
stopka ocelová	A10KSDQCR/L07	10	14	125	16	7	DCMT/DCGT0702..	-	-	VT25 B	TX8
	A12LSDQCR/L07	12	17	140	20	9					
	A16QSDQCR/L07	16	22	180	25	11					
	A20RSDQCR/L11	20	26	200	32	13	DCMT/DCGT11T3..	-	-	VT40 B	TX15
	A25RSDQCR/L11	25	31,5	200	40	17					
	A32SSDQCR/L11	32	40	250	33,5	22					
A40TSDQCR/L11	40	49	300	50	27	US2311	GBS1111	SS1111	TX15		

## Typ AH-SDQCR/L

	Název	Rozměry (mm)					Destičky	Náhradní díly			
		D	Dmin	L1	L2	F		Podložka	Šroubek podložky	Šroubek VBD	Klíč
stopka HSS	AH08KSDQCR/L07	8	12	125	20	8	DCMT/DCGT0702..	-	-	VT25 B	TX8
	AH10KSDQCR/L07	10	13	125	20	7					
	AH12MSDQCR/L07	12	16	150	20	8,5					
	AH16QSDQCR/L11	16	20	180	30	10	DCMT/DCGT11T3..	-	-	VT40 B	TX15
	AH20RSDQCR/L11	20	25	200	40	12,5					
	AH25RSDQCR/L11	25	32	200	40	16					

## Typ E-SDQCR/L

	Název	Rozměry (mm)					Destičky	Náhradní díly			
		D	Dmin	L1	L2	F		Podložka	Šroubek podložky	Šroubek VBD	Klíč
stopka karbidová	E08KSDQCR/L07	8	9,2	80	15	5	DCMT/DCGT0702..	-	-	VT25 B	TX8
	E10KSDQCR/L07	10	12,5	100	22	7					
	E12MSDQCR/L07	12	17	140	25	9					
	E16RSDQCR/L11	16	21	180	33	11	DCMT/DCGT11T3..	-	-	VT40 B	TX15
	E20SSDQCR/L11	20	25	200	40	13					
	E25SSDQCR/L11	25	31,5	200	50	17					





# Soustružnické nože vnitřní



odhlehčené s vnitřním chlazením

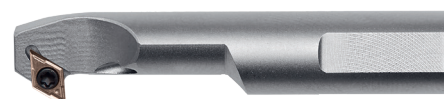

## Typ A-SDXCR/L

	Název	Rozměry (mm)					Destičky	Náhradní díly			
		D	Dmin	L1	L2	F		Podložka	Šroubek podložky	Šroubek VBD	Klíč
stopka ocelová	A08FSDXCR/L04	8	9,2	80	15	5	DCGT04T0..	-	-	VT1604	TX5
	A10HSDXCR/L04	10	12,5	100	22	7		-	-	-	-
	A12LSDXCR/L07	12	17	140	25	9	DCMT/DCGT0702..	-	-	VT25 B	TX8
	A16QSDXCR/L07	16	21	180	33	11		-	-	-	-
	A20RSDXCR/L11	20	25	200	40	13	DCMT/DCGT11T3..	-	-	VT40 B	TX15
	A25RSDXCR/L11	25	31,5	200	50	17		-	-	-	-

s vnitřním chlazením

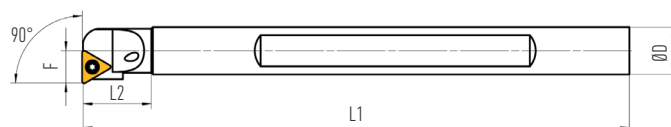

## Typ A-STFCR/L

	Název	Rozměry (mm)					Destičky	Náhradní díly			
		D	Dmin	L1	L2	F		Podložka	Šroubek podložky	Šroubek VBD	Klíč
stopka ocelová	A10KSTFCR/L11	10	13	125	22,8	7	TCMT/TCGT1102..	-	-	VT25 B	TX8
	A12LSTFCR/L11	12	16	140	26,5	9		-	-	-	-
	A16QSTFCR/L11	16	20	180	26,7	11	TCMT/TCGT16T3..	-	-	VT40 B	TX15
	A20RSTFCR/L16	20	25	200	36,6	13		-	-	-	-
	A25RSTFCR/L16	25	32	200	41	17	US5511	GBS1111	SS1111	TX15	
	A32SSTFCR/L16	32	40	250	34,6	21,9					
A40TSTFCR/L16	40	49	300	37,5	27	-	-	-	-		

## Typ AH-STFCR/L

	Název	Rozměry (mm)					Destičky	Náhradní díly			
		D	Dmin	L1	L2	F		Podložka	Šroubek podložky	Šroubek VBD	Klíč
stopka HSS	AH10KSTFCR/L11	10	12	125	16	7	TCMT/TCGT1102..	-	-	VT25 B	TX8
	AH12MSTFCR/L11	12	14	150	20	9		-	-	-	-
	AH16QSTFCR/L11	16	18	180	25	11	TCMT/TCGT16T3..	-	-	VT40 B	TX15
	AH20RSTFCR/L11	20	23	200	32	13		-	-	-	-
	AH25RSTFCR/L16	25	28	200	40	17	-	-	-	-	



# Soustružnické nože vnitřní



s vnitřním chlazením

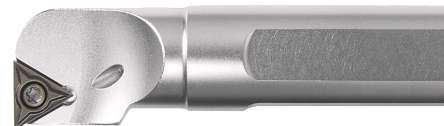

## Typ E-STFCR/L



Název	Rozměry (mm)					Destičky	Náhradní díly				
	D	Dmin	L1	L2	F		Podložka	Šroubek podložky	Šroubek VBD	Klíč	
stopka karbidová	E10KSTFCR/L11	10	12	125	16	6	TCMT/TCGT1102..	-	-	VT25 B	TX8
	E12MSTFCR/L11	12	15	150	20	8		-	-		
	E16RSTFCR/L11	16	19	200	25	10		-	-		
stopka karbidová	E20SSTFCR/L16	20	24	250	32	12	TCMT/TCGT16T3..	-	-	VT40 B	TX15
	E25SSTFCR/L16	25	27	250	40	13,5		-	-		

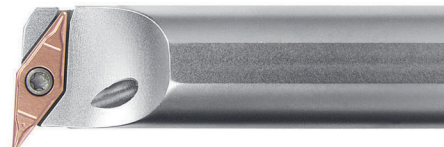
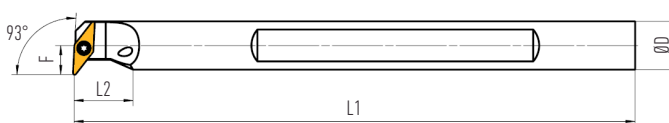

## Typ A-SVUBR/L



Název	Rozměry (mm)					Destičky	Náhradní díly						
	D	Dmin	L1	L2	F		Podložka	Šroubek podložky	Šroubek VBD	Klíč			
stopka ocelová	A16QSVUBR/L11	16	21	180	16,5	11	VBMT/VBGT1103..	-	-	VT25 B	TX8		
	A20RSVUBR/L11	20	25	200	20,5	13		-	-				
	A25RSVUBR/L16	25	32	200	25,5	17	VBMT/VBGT1604..	US6522	GBS1111	SS1111	TX15		
	A32SSVUBR/L16	32	40	250	33,5	22						-	-
	A40TSVUBR/L16	40	49	300	40	27						-	-

## Typ E-SVUBR/L



Název	Rozměry (mm)					Destičky	Náhradní díly				
	D	Dmin	L1	L2	F		Podložka	Šroubek podložky	Šroubek VBD	Klíč	
stopka karbidová	E16RSVUBR/L11	16	21	200	16,5	11	VBMT/VBGT1103..	-	-	VT25 B	TX8
	E20SSVUBR/L11	20	25	250	20,5	13		-	-		
	E25SSVUBR/L11	25	31,5	250	23	17		-	-		



# Soustružnické nože vnitřní



s vnitřním chlazením

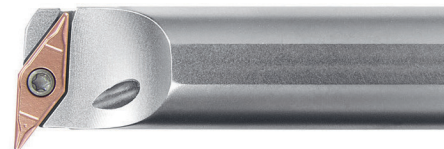
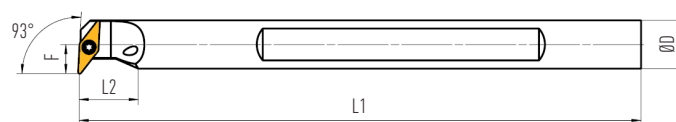

## Typ A-SVUCR/L



	Název	Rozměry (mm)					Destičky	Náhradní díly			
		D	Dmin	L1	L2	F		Podložka	Šroubek podložky	Šroubek VBD	Klíč
stopka ocelová	A16QSVUCR/L11	16	21	180	16,5	11	VCMT/VCGT1103..	-	-	VT25 B	TX8
	A20RSVUCR/L11	20	25	200	20,5	13		-	-	VT40 B	
	A25RSVUCR/L16	25	32	200	25,5	17	VCMT/VCGT1604..	US6522	GBS1111	SS1111	TX15
	A32SSVUCR/L16	32	40	250	33,5	22					
	A40TSVUCR/L16	40	49	300	40	27					

## Typ AH-SVUCR/L



	Název	Rozměry (mm)					Destičky	Náhradní díly			
		D	Dmin	L1	L2	F		Podložka	Šroubek podložky	Šroubek VBD	Klíč
stopka HSS	AH16QSVUCR/L11	16	21	180	20	11	VCMT/VCGT1103..	-	-	VT25 B	TX8
	AH20RSVUCR/L11	20	25	200	24	13		-	-	VT40 B	
	AH25RSVUCR/L16	25	31,5	200	25,5	17	VCMT/VCGT1604..	-	-	VT40 B	TX15

## Typ E-SVUCR/L



	Název	Rozměry (mm)					Destičky	Náhradní díly			
		D	Dmin	L1	L2	F		Podložka	Šroubek podložky	Šroubek VBD	Klíč
stopka karbidová	E16RSVUCR/L11	16	21	200	16,5	11	VCMT/VCGT1103..	-	-	VT25 B	TX8
	E20SSVUCR/L11	20	25	250	20,5	13					
	E25SSVUCR/L16	25	31,5	250	23	17					



# Soustružnické nože vnitřní



s vnitřním chlazením

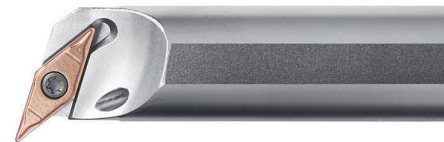
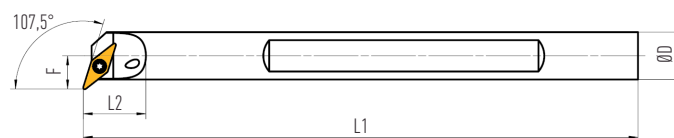

## Typ A-SVQBR/L



Název	Rozměry (mm)					Destičky	Náhradní díly				
	D	Dmin	L1	L2	F		Podložka	Šroubek podložky	Šroubek VBD	Klíč	
stopka ocelová	A16QSVQBR/L11	16	21	180	16,5	11	VBMT/VBGT1103..	-	-	VT25 B	TX8
	A20RSVQBR/L11	20	25	200	20,5	13		-	-	VT40 B	TX15
	A25RSVQBR/L16	25	32	200	40	17	VBMT/VBGT1604..	-	-	VT40 B	TX15

## Typ A-SVQCR/L



Název	Rozměry (mm)					Destičky	Náhradní díly				
	D	Dmin	L1	L2	F		Podložka	Šroubek podložky	Šroubek VBD	Klíč	
stopka ocelová	A16QSVQCR/L11	16	21	180	16,5	11	VCMT/VCGT1103..	-	-	VT25 B	TX8
	A20RSVQCR/L11	20	24	200	26,1	13		-	-	VT40 B	TX15
	A25RSVQCR/L16	25	31,5	200	43	17	VCMT/VCGT1604..	US6522	GBS1111	SS1111	TX15
	A32SSVQCR/L16	32	40	250	33,5	22					
	A40TSVQCR/L16	40	49	300	40	27					

odlehčené s vnitřním chlazením

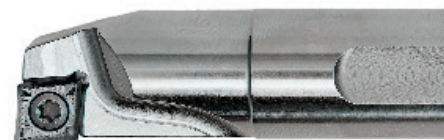
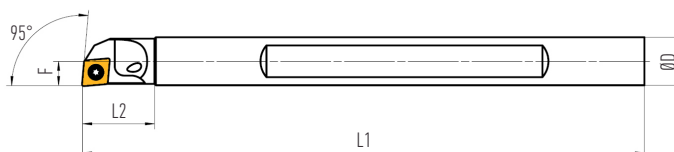

## Typ A-SCLCR/L



Název	Rozměry (mm)					Destičky	Náhradní díly		
	D	Dmin	L1	L2	F		Šroubek VBD	Klíč	
stopka ocelová	A08HSCLCR/L06-OD	8	10	100	20	5	CCMT/CCGT0602..	VT25 B	TX8
	A10KSCLCR/L06-OD	10	12	125	20	6			
	A12LSCLCR/L06-OD	12	14	140	24,2	7			
	A16QSCLCR/L09-OD	16	18	180	31	9	CCMT/CCGT09T3..	VT40 B	TX15
	A20RSCLCR/L09-OD	20	22	200	36	11			
	A25RSCLCR/L09-OD	25	27	200	43	13,5			
A25RSCLCR/L12-OD	25	27	200	43	13,5	CCMT/CCGT1204..	VT50	TX20	



# Soustružnické nože vnitřní



odlehčené s vnitřním chlazením

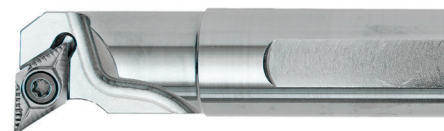
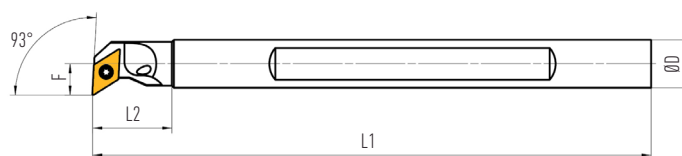

## Typ A-SDUCR/L



	Název	Rozměry (mm)					Destičky	Náhradní díly	
		D	Dmin	L1	L2	F		Šroubek VBD	Klíč
stopka ocelová	A10KSDUCR/L07-OD	10	13	125	20	7	DCMT/DCGT0702..	VT25 B	TX8
	A12LSDUCR/L07-OD	12	15	140	25	8			
	A16QSDUCR/L07-OD	16	19	180	28	10			
	A16QSDUCR/L11-OD	16	23	180	28	14	DCMT/DCGT11T3..	VT40 B	TX15
	A20RSDUCR/L11-OD	20	25	200	36	13			
	A25RSDUCR/L11-OD	25	31	200	40	16			

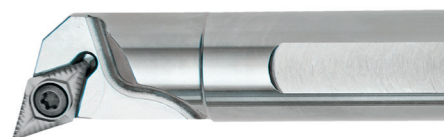
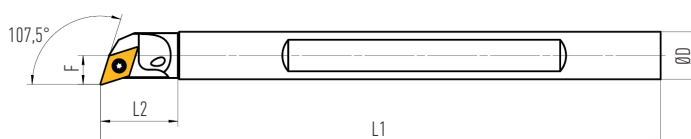

## Typ A-SDQCR/L



	Název	Rozměry (mm)					Destičky	Náhradní díly	
		D	Dmin	L1	L2	F		Šroubek VBD	Klíč
stopka ocelová	A10KSDQCR/L07-OD	10	13	125	20	7	DCMT/DCGT0702..	VT25 B	TX8
	A12LSDQCR/L07-OD	12	15	140	25	8			
	A16QSDQCR/L07-OD	16	19	180	28	10			
	A16QSDQCR/L11-OD	16	23	180	28	14	DCMT/DCGT11T3..	VT40 B	TX15
	A20RSDQCR/L11-OD	20	25	200	36	13			
	A25RSDQCR/L11-OD	25	31	200	40	16			



# Soustružnické nože vnitřní



odlehčené s vnitřním chlazením

## Typ A-STFCR/L

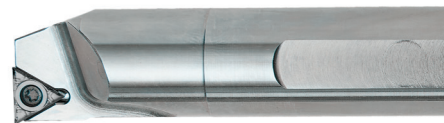
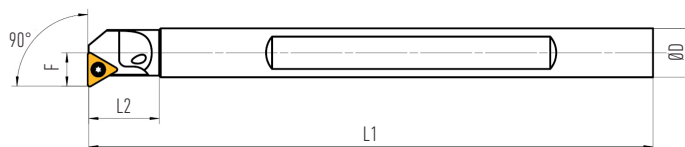

	Název	Rozměry (mm)				Destičky	Náhradní díly		
		D	Dmin	L1	L2		F	Šroubek VBD	Klíč
stopka ocelová	A10KSTFCR/L11-OD	10	12	125	22	6	TCMT/TCGT1102..	VT25 B	TX8
	A12LSTFCR/L11-OD	12	14	140	24,3	7			
	A16QSTFCR/L11-OD	16	18	180	31	9			
	A20RSTFCR/L11-OD	20	22	200	36	11			

## Typ A-SVUBR/L

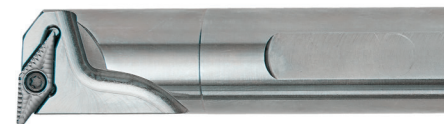
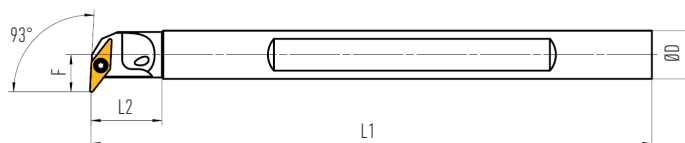

	Název	Rozměry (mm)				Destičky	Náhradní díly		
		D	Dmin	L1	L2		F	Šroubek VBD	Klíč
stopka ocelová	A16QSVUBR/L11-OD	16	20	180	31	11	VBMT/VBGT1103..	VT25 B	TX8
	A20RSVUBR/L11-OD	20	24	200	36	13			
	A25RSVUBR/L11-OD	25	31	200	40	17			

## Typ A-SVUCR/L



	Název	Rozměry (mm)				Destičky	Náhradní díly		
		D	Dmin	L1	L2		F	Šroubek VBD	Klíč
stopka ocelová	A16QSVUCR/L11-OD	16	20	180	31	11	VCMT/VCGT1103..	VT25 B	TX8
	A20RSVUCR/L11-OD	20	24	200	36	13			
	A25RSVUCR/L11-OD	25	31	200	40	17			





Lined writing area with 30 horizontal lines.

# ≡ myšlenky a plány ≡







Sídlo  
Plzeňská 610, 338 05 Mýto

 [tgs@tgs.cz](mailto:tgs@tgs.cz)

Provozovna  
Plzeňská 610, 338 05 Mýto

[www.tgs.cz](http://www.tgs.cz)

ETGSE

